

DE BEDINUNGSANLEITUNG
RU ИНСТРУКЦИЯ
FR MANUEL INSTRUCTIONS
GB INSTRUCTION MANUAL

RO INSTRUCTIUNI DE UTILIZARE
PL INSTRUKCJA OBSŁUGI
TR KILAVUZUNU

SLO NAVODILO ZA UPORABO
IT MANUALE DI ISTRUZIONI
SK NÁVOD NA OBSLUHU

NL GEBRUIKSAANWIJZING
HU HASZNÁLATI UTASÍTÁS
CZ NÁVOD K OBSLUZE

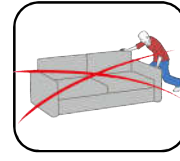

1

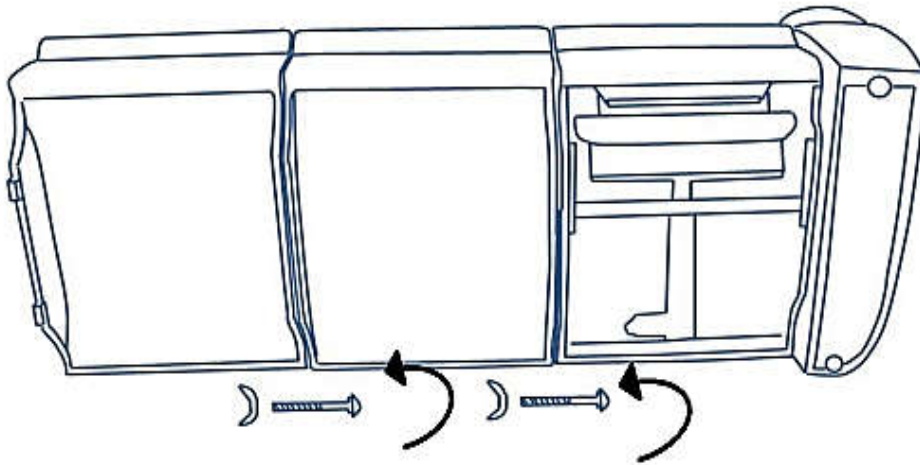

2

3

4

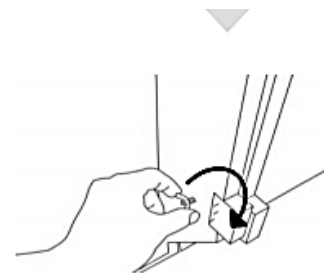
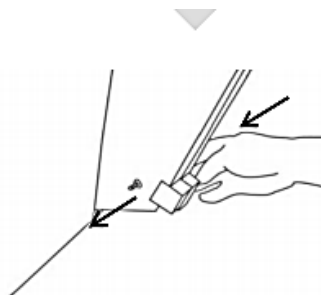
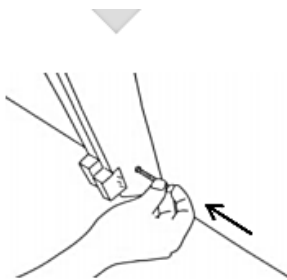

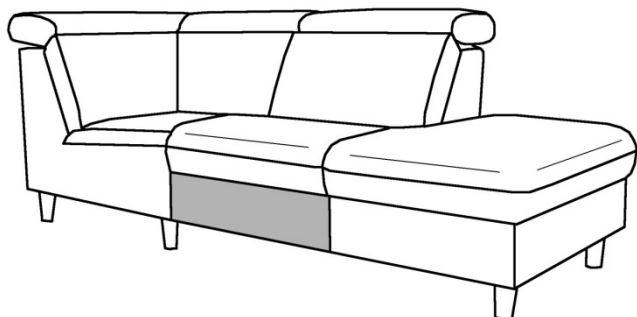
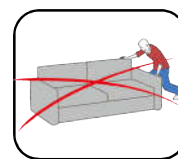

Max. 10kg

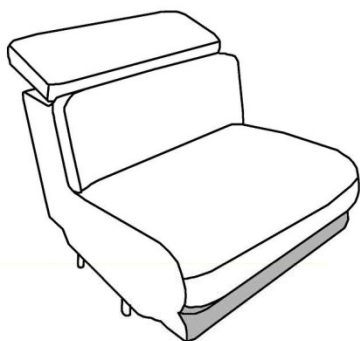
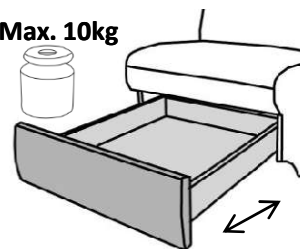

Max. 10kg

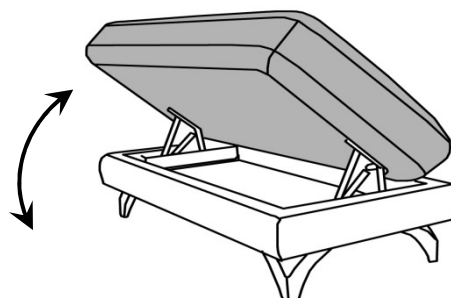
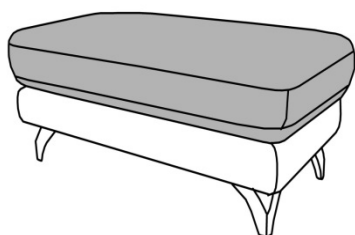
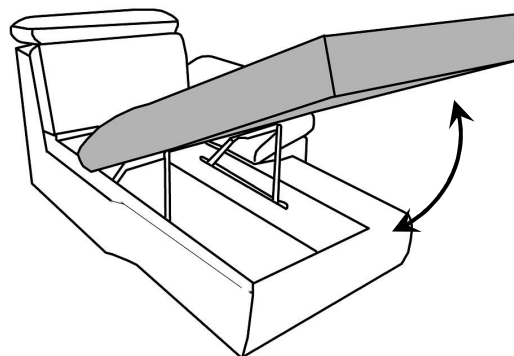
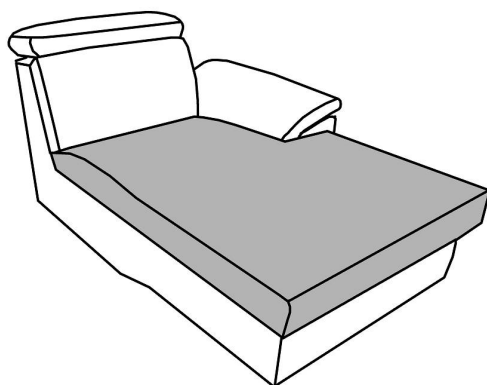
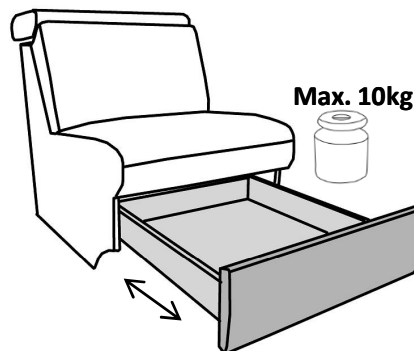

DE BEDINUNGSANLEITUNG
RU ИНСТРУКЦИЯ
FR MANUEL INSTRUCTIONS
GB INSTRUCTION MANUAL

RO INSTRUCTIUNI DE UTILIZARE
PL INSTRUKCJA OBSŁUGI
TR KILAVUZUNU

SLO NAVODILO ZA UPORABO
IT MANUALE DI ISTRUZIONI
SK NÁVOD NA OBSLUHU

NL GEBRUIKSAANWIJZING
HU HASZNÁLATI UTASÍTÁS
CZ NÁVOD K OBSLUZE

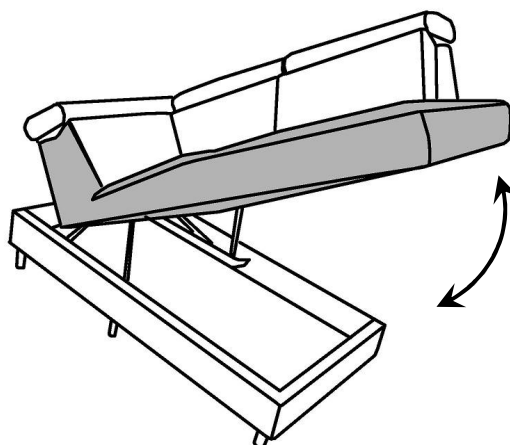
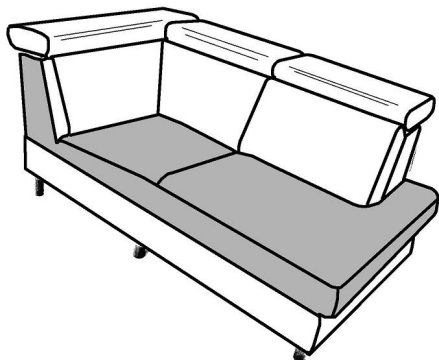
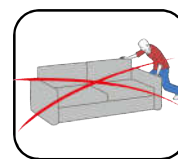

DE BEDINUNGSANLEITUNG
RU ИНСТРУКЦИЯ
FR MANUEL INSTRUCTIONS
GB INSTRUCTION MANUAL

RO INSTRUCȚIUNI DE UTILIZARE
PL INSTRUKCJA OBSŁUGI
TR KILAVUZUNU

SLO NAVODILO ZA UPORABO
IT MANUALE DI ISTRUZIONI
SK NÁVOD NA OBSLUHU

NL GEBRUIKSAANWIJZING
HU HASZNÁLATI UTASÍTÁS
CZ NÁVOD K OBSLUZE

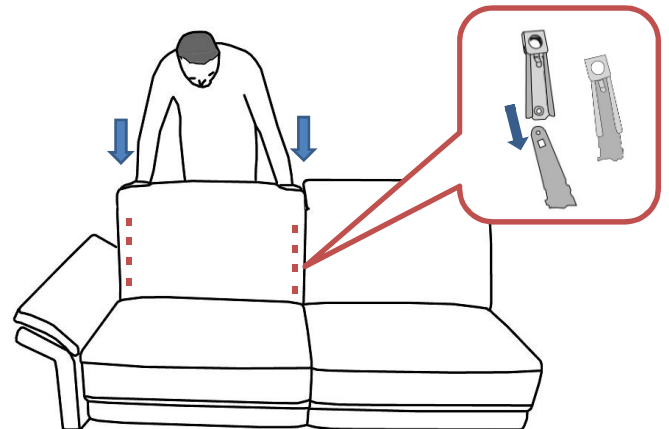
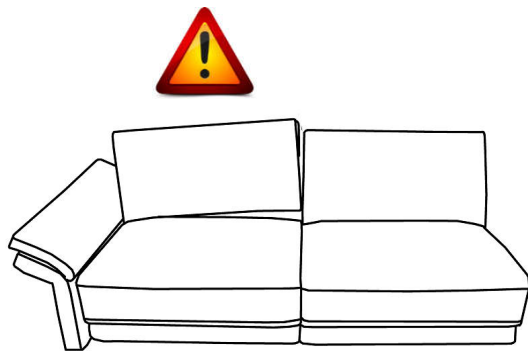
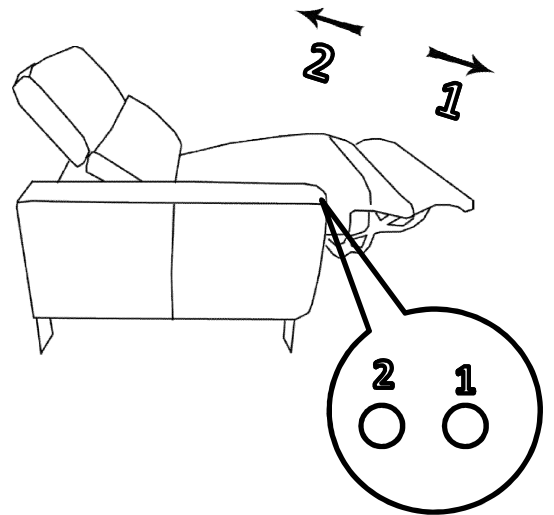
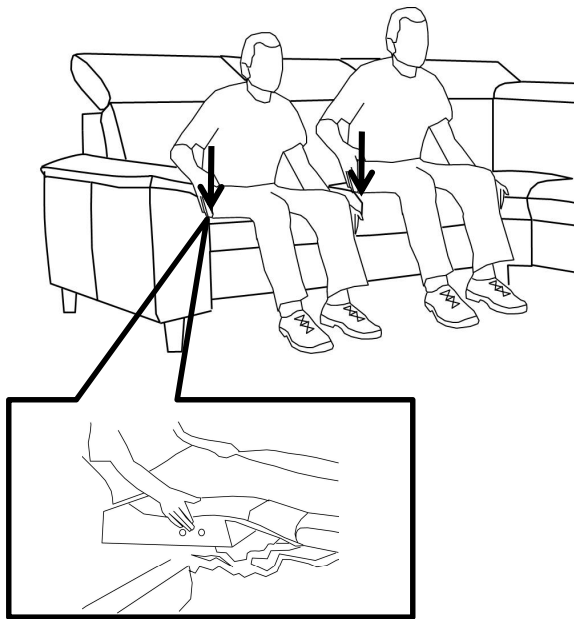
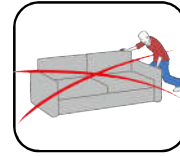

DE BEDINUNGSANLEITUNG
RU ИНСТРУКЦИЯ
FR MANUEL INSTRUCTIONS
GB INSTRUCTION MANUAL

RO INSTRUȚIUNI DE UTILIZARE
PL INSTRUKCJA OBSŁUGI
TR KILAVUZUNU

SLO NAVODILO ZA UPORABO
IT MANUALE DI ISTRUZIONI
SK NÁVOD NA OBSLUHU

NL GEBRUIKSAANWIJZING
HU HASZNÁLATI UTASÍTÁS
CZ NÁVOD K OBSLUZE

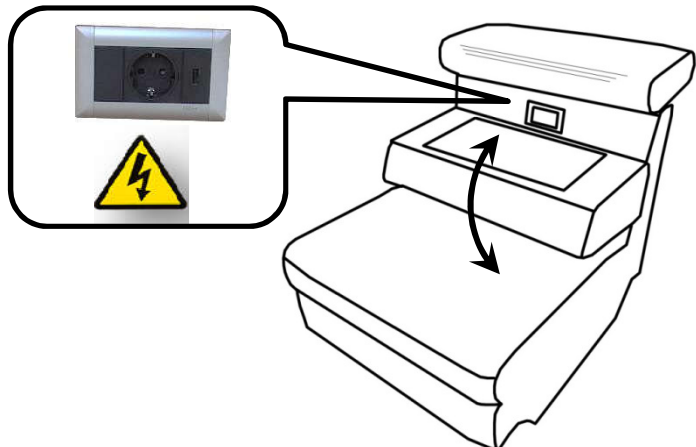
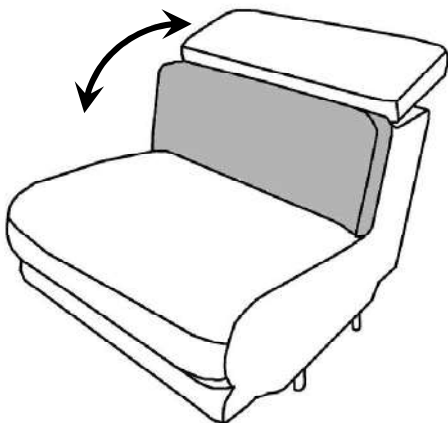
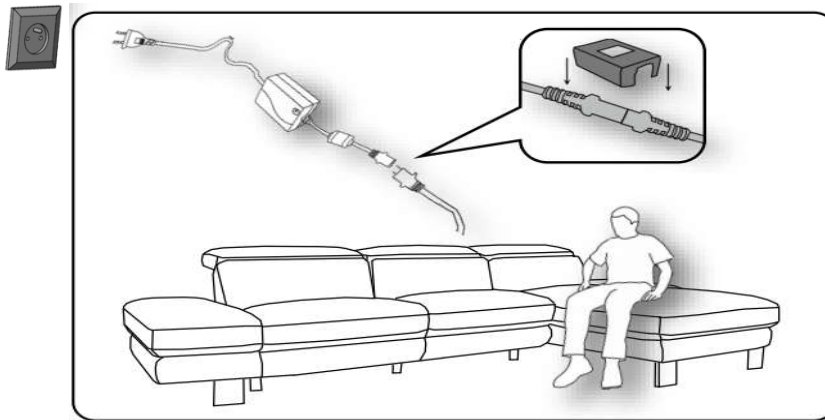
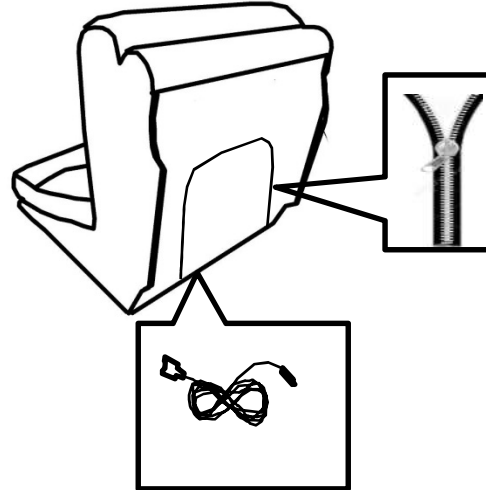
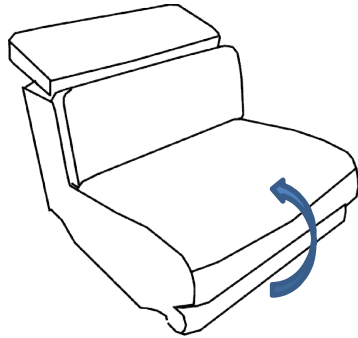
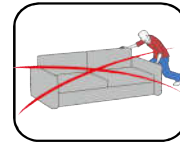

DE BEDINUNGSANLEITUNG
RU ИНСТРУКЦИЯ
FR MANUEL INSTRUCTIONS
GB INSTRUCTION MANUAL

RO INSTRUCȚIUNI DE UTILIZARE
PL INSTRUKCJA OBSŁUGI
TR KILAVUZUNU

SLO NAVODILO ZA UPORABO
IT MANUALE DI ISTRUZIONI
SK NÁVOD NA OBSLUHU

NL GEBRUIKSAANWIJZING
HU HASZNÁLATI UTASÍTÁS
CZ NÁVOD K OBSLUZE

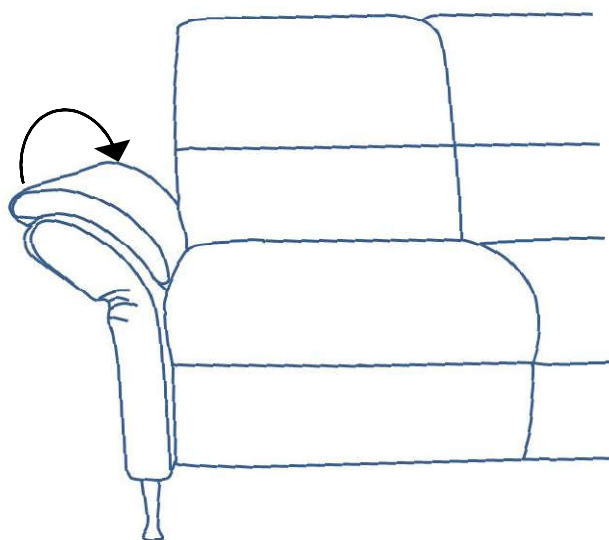
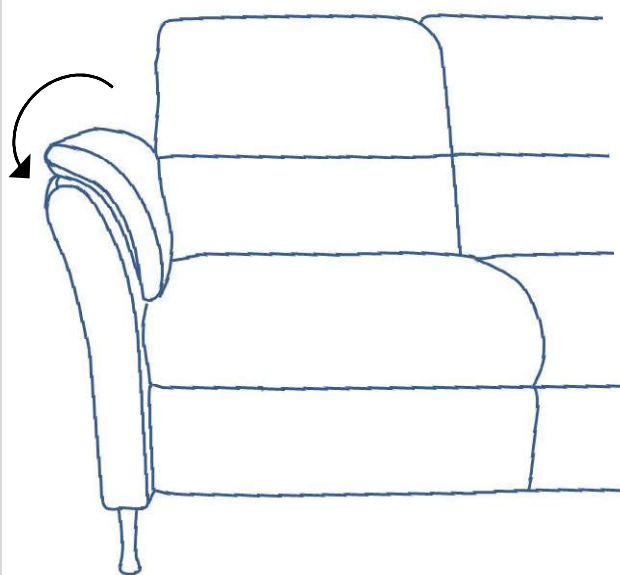
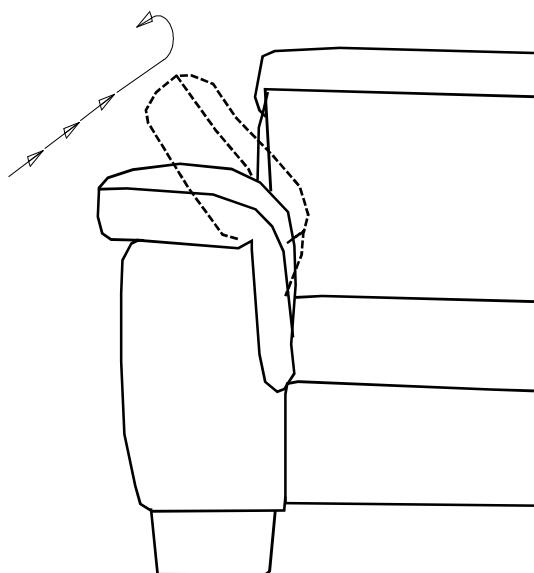
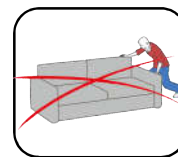

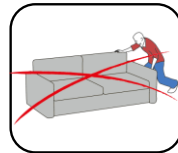

Manuell

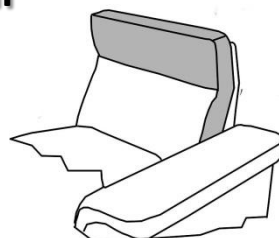

Motor

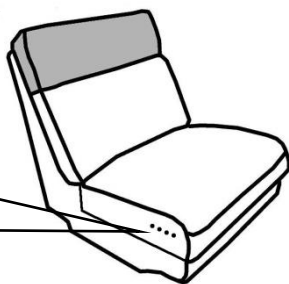
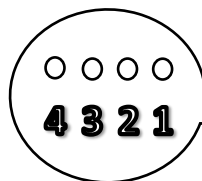

Manuell

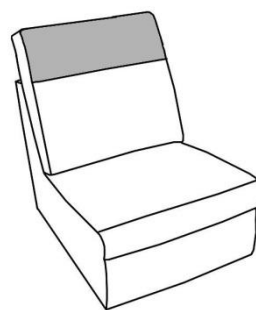
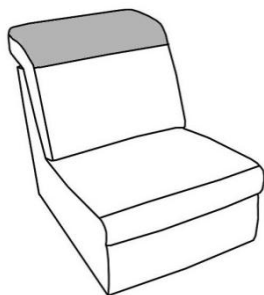

Motor

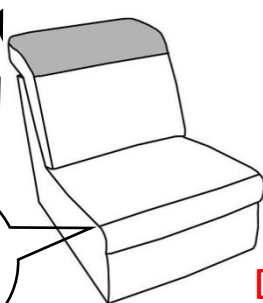
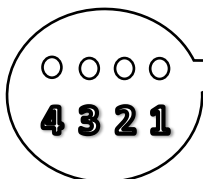

D1K0026

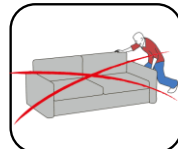

Manuell

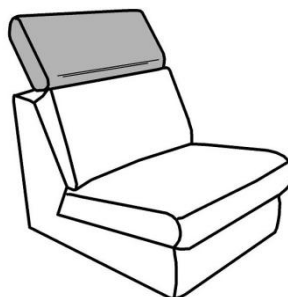
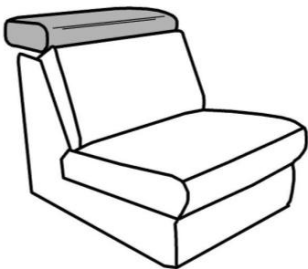

Motor

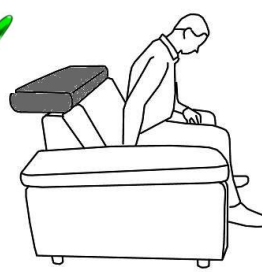
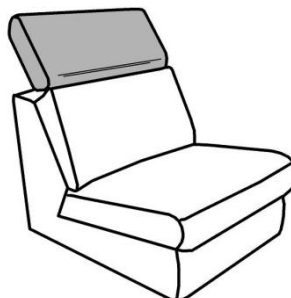
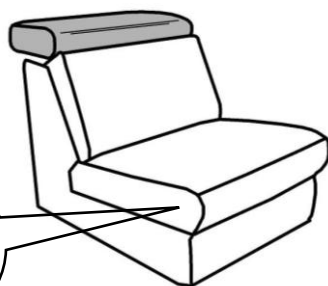

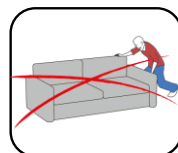

Manuell

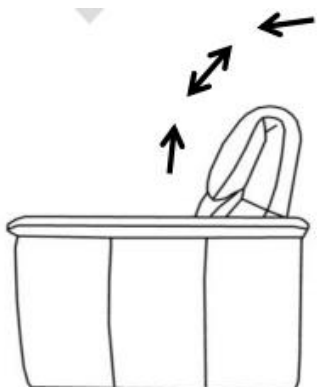

DE BEDIENUNGSANLEITUNG
RU ИНСТРУКЦИЯ
FR MANUEL INSTRUCTIONS

GB INSTRUCTION MANUAL
TR KILAVUZUNU
IT MANUALE DI ISTRUZIONI

PL INSTRUKCJA OBSŁUGI
RO INSTRUCȚIUNI DE UTILIZARE
SK NÁVOD NA OBSLUHU

NL GEBRUIKSAANWIJZING
HU HASZNÁLATI UTASÍTÁS
CZ NÁVOD K OBSLUZE

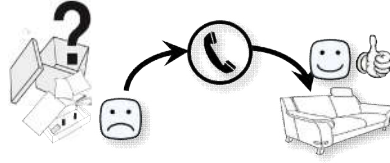

| | | | |
|--|--|--|--|
| | | | |
| | | | |
| | | | |
| | | | |
| | | | |

DE BEDIENUNGSANLEITUNG
RU ИНСТРУКЦИЯ
FR MANUEL INSTRUCTIONS

GB INSTRUCTION MANUAL
TR KILAVUZUNU
IT MANUALE DI ISTRUZIONI

PL INSTRUKCJA OBSŁUGI
RO INSTRUCȚIUNI DE UTILIZARE
SK NÁVOD NA OBSLUHU

NL GEBRUIKSAANWIJZING
HU HASZNÁLATI UTASÍTÁS
CZ NÁVOD K OBSLUZE

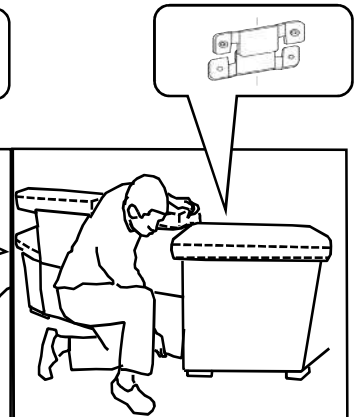
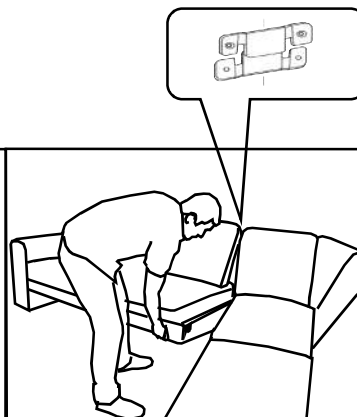
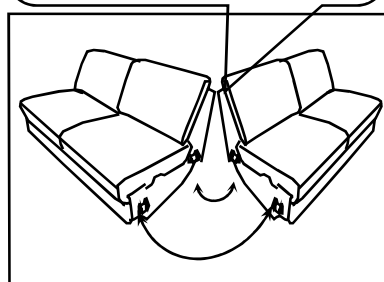
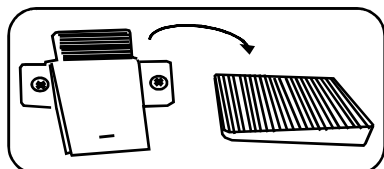
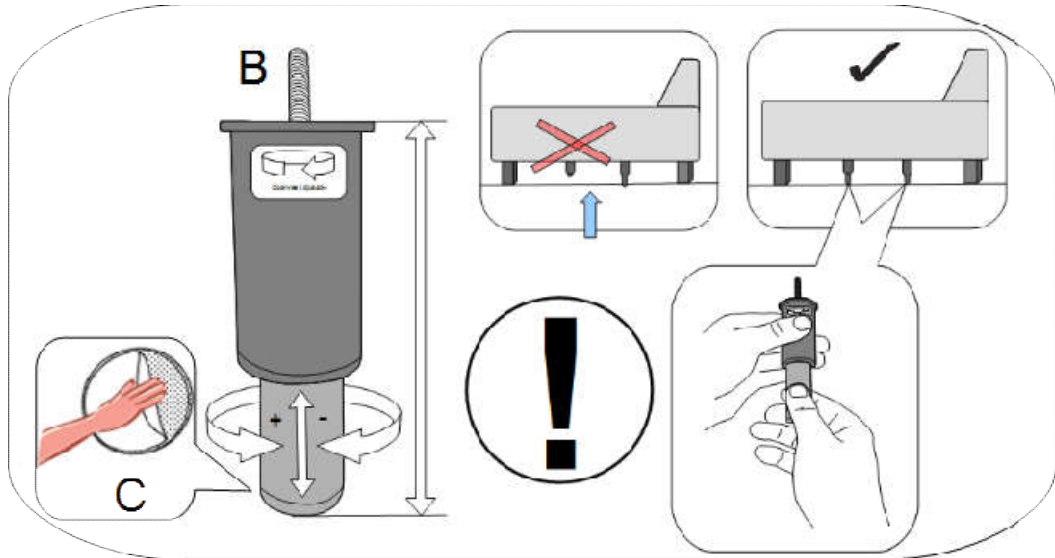
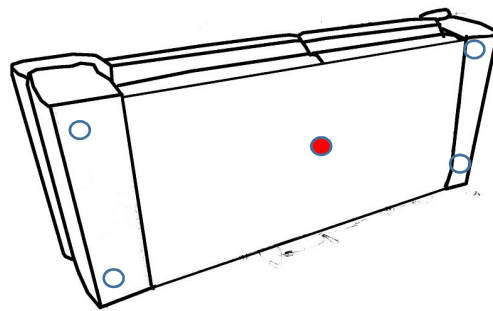
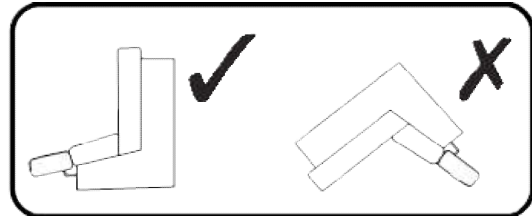
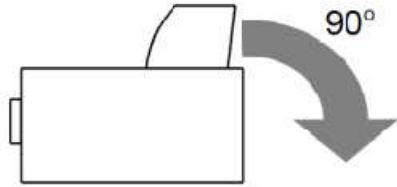
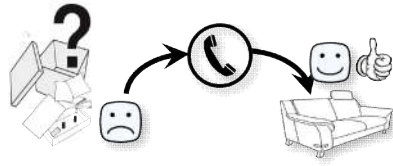

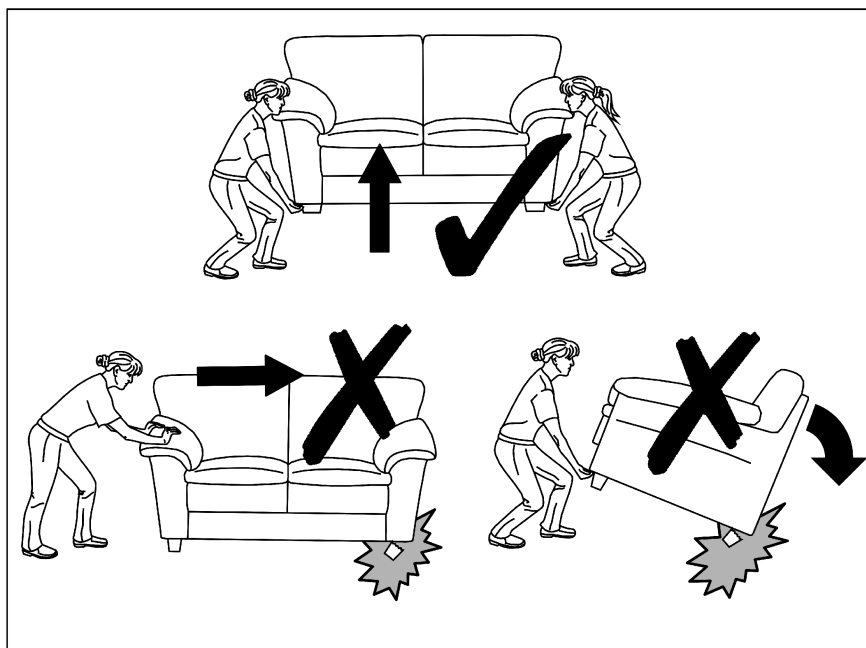
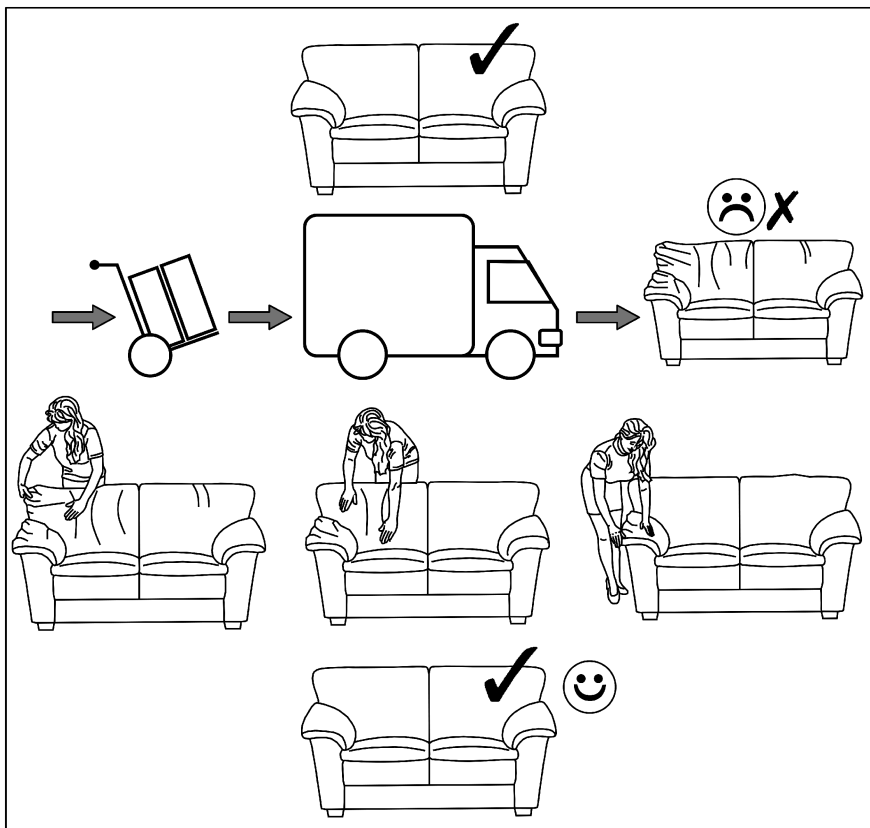
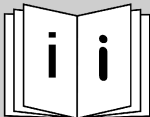

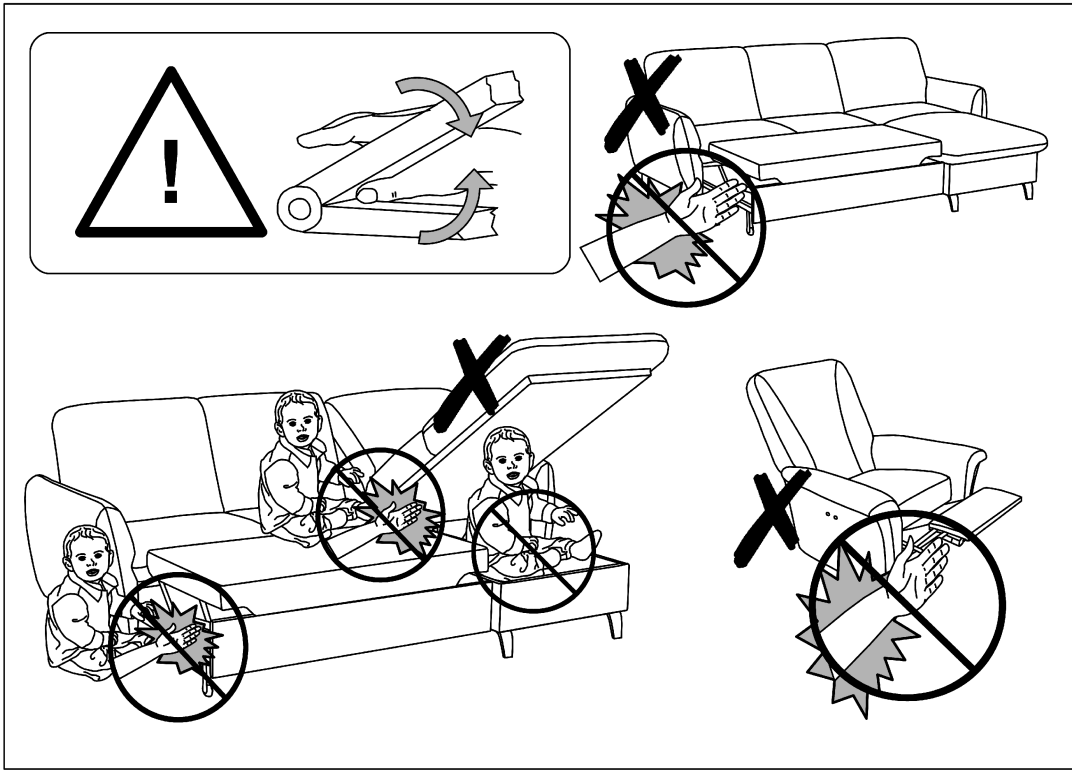
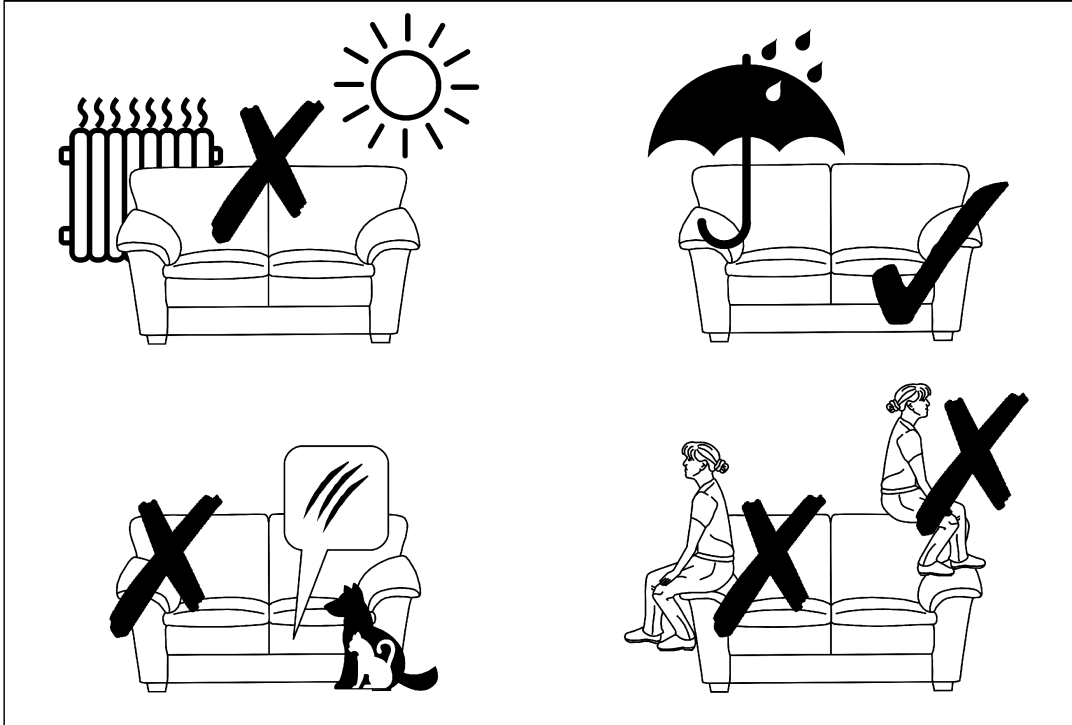

(DE) PFLEGEHINWEISE:

1. SORGFÄLTIG ENTSTAUBEN
2. MIT EINEM WEICHEN, SAUBEREN UND FEUCHTEM TUCH UND LEICHTER SEIFENLAUGE REINIGEN

| | DEKOR PAPIER | OBERFLÄCHE LAMINAT | OBERFLÄCHE LACK | LACKIERTEN HOLZ | TEXTIL LEDER |
|----------------------------------|--------------|--------------------|-----------------|-----------------|--------------|
| SEIFENLAUGE (NEUTRAL SEIFE) | ✓ | ✓ | ✓ | ✓ | ✓ |
| WASSER MIT HAUSHALTREINIGER | | ✓ | ✓ | | |
| REINIGUNG NACH HERSTELLERVORGABE | | | | | ✓ |

- BENUTZEN SIE KEINE SCHEUERMITTEL WIE PULVER, STAHLWOLLE, LÖSUNGSMITTEL
- NICHT ZU NASS ABWISCHEN

(GB) CONSERVATION ADVICES:

1. CAREFULLY WIPE OFF THE DUST
2. MOISTEN A SOFT, CLEAN CLOTH WITH SOAPY WATER

| | VEENEER WOOD | LAMINATE SURFACE | LAMINATED WOOD SURFACE | VARNISHED SURFACE | FABRIC LEATHER |
|--|--------------|------------------|------------------------|-------------------|----------------|
| WATER WITH SOAP (GREY SOAP) | ✓ | ✓ | ✓ | ✓ | ✓ |
| WATER WITH DETERGENT | | ✓ | ✓ | | |
| MAINTENANCE PRESCRIBED BY THE MANUFACTURER | | | | | ✓ |

- DO NOT USE ABRASIVE PRODUCTS: POWDERS, STEEL WOOL, SOLVENTS
- DO NOT OVER-WET

(FR) CONSEILS D'ENTRETIEN:

1. DÉPOUSSIERER SOIGNEUSEMENT
2. HUMIDIFIER UN CHIFFON DOUX ET PROPRE D'EAU SAVONNEUSE

| | BOIS DE PLACAGE | SURFACES STRATIFIÉES | SURFACES LAQUÉES | BOIS VERNIS | TISSU CUIR |
|--------------------------------|-----------------|----------------------|------------------|-------------|------------|
| EAU SAVONNEUSE (SAVON NEUTRE) | ✓ | ✓ | ✓ | ✓ | ✓ |
| EAU ADDITIONNÉE DE DÉTERGENT | | ✓ | ✓ | | |
| ENTRETIEN SPÉCIFIQUE FABRICANT | | | | | ✓ |

- NE JAMAIS UTILISER DE PRODUITS ABRASIFS: POUDRE À RÉCURER, LAINE D'ACIER, SOLVANTS
- NE PAS TROP MOUILLER

(PL) PORADY W ZAKRESIE KONSERWACJI:

1. ZETRZEĆ DOKŁADNIE KURZ
2. CZYSTĄ I DELIKATNĄ ŚCIERECZKĘ ZWILŻYĆ LEKKO W WODZIE Z NIEWIELKĄ ILOŚCIĄ MYDŁA

| | OKLEINA | POWIERZCHNIA LAMINATU | POW. DREWNA LAKOWANEGO | POWIERZCHNIA LAKIEROWANA | TKANINA SKÓRA |
|--|---------|-----------------------|------------------------|--------------------------|---------------|
| WODA Z MYDŁEM (SZARE MYDŁO) | ✓ | ✓ | ✓ | ✓ | ✓ |
| WODA Z DODATKIEM ŚRODKA MYJĄCEGO | | ✓ | ✓ | | |
| KONSERWACJA ŚCIŚLE WEDŁUG ZALECEŃ PRODUCENTA | | | | | ✓ |

- NIGDY NIE UŻYWAĆ PRODUKTÓW ŚCIERNYCH: PROSZKÓW, DRAPAKÓW, ROZPUSZCZALNIKÓW
- NIE MOCZYĆ DUŻĄ ILOŚCIĄ WODY

(IT) CONSIGLI PER LA MANUTENZIONE:

1. SPOLVERATE ACCURATAMENLE
2. INUMIDIRE CON ACQUA LEGGERMENTE INSAPONATA UNO STRACCIO MORBIDO PULITO

| | CARTA | SUPERFICIE STRATIFICATA | SUPERFICIE LACCATE | LACCATE E LEGNO VERNICIATO | TESSILE PELLE |
|-----------------------------------|-------|-------------------------|--------------------|----------------------------|---------------|
| ACQUA CON SAPONE (SAPONE NEUTRO) | ✓ | ✓ | ✓ | ✓ | ✓ |
| ACQUA CON DETERSIVO SAN MARO | | ✓ | ✓ | | |
| MANUTENZIONE SPECIFICA PRODUTTORE | | | | | ✓ |

- NON UTILIZZARE MAI PRODOTTI ABRASIVI: POLVERE, LANA DI ACCIAIO, SOLVENTI
- NON BAGNARE TROPPO

(ES) CONSEJOS PARA EL MANTENIMIENTO:

1. LIMPIAR EL POLVO CON CUIDADO
2. HUMEDECER UN PAÑO SUAVE Y LIMPIO CON AGUA LIGERAMENTE ENJABONADA

| | CHAPA DE MADERA | SUPERFICIE LAMINADA | MADERA BARNIZADA | SUPERFICIE LACADA | TELA PIEL |
|---|-----------------|---------------------|------------------|-------------------|-----------|
| AGUA Y JABON (JABON NEUTRO) | ✓ | ✓ | ✓ | ✓ | ✓ |
| AGUA CON DETERGENTE | | ✓ | ✓ | | |
| MANTENIMIENTO ESPECIFICO DEL FABRICANTE | | | | | ✓ |

- NO USE NUNCA PRODUCTOS ABRASIVOS TALES COMO POLVO DE LIMPIAR, RASCADOR, DISOLVENTES
- NO MOJAR EXAGERADAMENTE

(PT) CONSELHOS PARA A MANUTENÇÃO:

1. LIMPE O POEIRO COM CUIDADO
2. UMEDECER UM PAÑO SUAVE E LIMPO COM AGUA E UM POUCO DE SABAO

| | PLACA DE MADERA | SUPERFÍCIE LAMINADA | MADEIRA ENVERNIZADA | SUPERFÍCIE LACADA | TELA PELE |
|-------------------------------|-----------------|---------------------|---------------------|-------------------|-----------|
| AGUA COM SABÃO (SABÃO NEUTRO) | ✓ | ✓ | ✓ | ✓ | ✓ |
| AGUA COM ST MARC | | ✓ | ✓ | | |
| INSTRUÇÕES ESPECIFICAS | | | | | ✓ |

- NUNCA UTILIZAR PRODUTOS ABRASIVOS POS, LA DE AÇO, SOLVENTES
- NAO MOLHAR DEMASIADO

(SK) TYPY NA ÚDRŽBU:

1. PRACH DOKŁADNE UTRITE
2. ČISTU A JEMNU HANDRIČKU NAVLHČIŤ LAHKO VO VODE Z MALÝM MNOŽSTVOM MYDLA

| | TENKÁ LAMINÁTOVÁ | LAMINÁTOVÝ POVRCH | DREVENÝ POVRCH LAKOVANÝ | LAKOVANÝ POVRCH | TKANINA ČALÚDNEŤ |
|---------------------------------|------------------|-------------------|-------------------------|-----------------|------------------|
| WODA Z MYDŁOM | ✓ | ✓ | ✓ | ✓ | ✓ |
| WODA Z UMYVAJÚCIM PROSTRIEDKOM | | ✓ | ✓ | | |
| ÚDRŽBA IBA PODĽA POPISU VÝROBCU | | | | | ✓ |

- NIKDY NEPOUŽÍVAŤ PROSTRIEDKY S DRSNÝM POVRCHOM : PRAŠKOV, DROBENIEK A RIEDIDIEL• NENAMÁČAJTE VEĽKÝM MNOŽSTVOM VODY

(CZ) TYPY NA UDRŽBU:

1. DŮKLADNĚ OTRIT PRACH
2. ČISTÝ A MĚKKÝ HADRÍK LEHCE NAVLHČIT VE VODĚ S MALÝM MNOŽSTVÍM MÝDLA

| | DÝHA | LAMINÁTOVÝ POVRCH | LAKOVANÝ DŘEVĚNÝ POVRCH | LAKOVANÝ POVRCH | KOŽENÁ ČALOUNĚNÁ LÁTKA |
|---|------|----------------------|----------------------------|--------------------|---------------------------|
| VODA S MÝDLEM | ✓ | ✓ | ✓ | ✓ | ✓ |
| VODA S ČISTIČÍM PROSTŘEDKEM | | ✓ | ✓ | | |
| DODRŽET ÚDRŽBU POSKYTOVANOU VÝROBCEM | | | | | ✓ |
| • NEPOUŽÍVEJTE ABRÁZIVNÍ PROSTŘEDKY: PRASEK, ROZPOUSTĚDLA • NENAMACĚJTE VELKÉ MNOŽSTVÍ VODY | | | | | |

(NL) ONDERHOUDSVOORSCHRIFT:

1. ZORGVULDIG STOFVRIJ MAKEN
2. MET EEN ZACHTE SCHONE EN VOCHTIGE DOEK MET NEUTRALE ZEEP REINIGEN

| | FOLIE | TOPLAAG LAMINAAT | TOPLAAG LAK | GELAKT HOUT | TEXTIEL LEER |
|--|-------|---------------------|----------------|-------------|-----------------|
| NEUTRALE ZEEP | ✓ | ✓ | ✓ | ✓ | ✓ |
| WATER MET HUISHOUD REINIGINGSMIDDEL | | ✓ | ✓ | | |
| DOOR DE PRODUCENT GESPECIFICEERD ONDERHOUD | | | | | ✓ |
| • GEBRUIKT U GEËN SCHUURMIDDELEN ZOALS SCHUURPOEDER, STAALWOL, OPLOSMIDDEL • NIET TE NAT AFNEMEN | | | | | |

(HU) KARBANTARTÁSI TANÁCSOK:

1. ALAPOSAN LETÖRÖLNI A PORT
2. EGY TISZTA ÉS LÁGY TÖRLŐKENDŐT BENEDVESÍTENI ENYHÉN SZAPPANOS VÍZZEL

| | FURNÉR | LAMINÁLT FELÜLET | LAKKOZOTT FAFELÜLET | LAKKOZOTT FELÜLET | BŐRKÁRPIT |
|---|--------|---------------------|------------------------|----------------------|-----------|
| SZAPPANOS VÍZ (MOSÓSZAPPAN) | ✓ | ✓ | ✓ | ✓ | ✓ |
| MOSÓSZERES VÍZ | | ✓ | ✓ | | |
| KARBANTARTÁS SZIGORÚAN A GYÁRTÓ UTASÍTÁSAI SZERINT | | | | | ✓ |
| • SOHA NE HASZNÁLJON SÚROLO HATASU TISZTÍTOSZERT: PORT, KAPAROT, OLDOSZERT • NE ZATASSA BO VÍZZEL | | | | | |

(RO) SFATURI PENTRU ÎNTREȚINERE:

1. ȘTERGEȚI BINE PRAFUL
2. UMEZIȚI UȘOR O LAVETĂ USCATĂ ȘI DELICATĂ ÎN APĂ CU PUȚIN SĂPUN

| | FURNIR | SUPRAFAȚĂ LAMINAT | SUPRAFAȚĂ LEMN LĂCUIȚ | SUPRAFAȚĂ LĂCUIȚĂ | ȚESĂTURĂ CĂPTUȘEALE PIELE |
|---|--------|----------------------|--------------------------|----------------------|------------------------------|
| APĂ CU SĂPUN | ✓ | ✓ | ✓ | ✓ | ✓ |
| APĂ CU DETERGENT | | ✓ | ✓ | | |
| ÎNȚREȚINEȚI ÎN CONFORMITATE STRICTĂ CU RECOMANDĂRILE PRODUCĂTORULUI | | | | | ✓ |
| • NU FOLOSIȚI NICIODATĂ PRODUSE ABRAZIVE: DETERGENȚI PRF, ZGĂRIETOARE, DILUANȚI • NU SPĂLAȚI CU O CANTITATE MARE DE APĂ | | | | | |

(RU) РЕКОМЕНДАЦИИ ПО УХОДУ:

1. ТЩАТЕЛЬНО ВЫТЕРЕТЬ ПЫЛЬ
2. ЧИСТУЮ И МЯГКУЮ ТРЯПОЧКУ СЛЕГКА УВЛАЖНИТЬ В ВОДЕ С НЕБОЛЬШИМ КОЛИЧЕСТВОМ МЫЛА

| | ОБЛИЦОВКА | ЛАМИНИРУЮЩА Я ПЛЁНКА | ПОВЕРХНОСТЬ ЛАКИРОВАННОЙ ДРЕВЕСИНЫ | ЛАКИРОВАННАЯ ПОВЕРХНОСТЬ | ОБИЧОВНАЯ ТКАНЬ, КОЖА |
|---|-----------|-------------------------|--|-----------------------------|--------------------------|
| ВОДА С МЫЛОМ (ХОЗЯЙСТВЕННОЕ МЫЛО) | ✓ | ✓ | ✓ | ✓ | ✓ |
| ВОДА С ДОБАВКОЙ МОУЩЕГО СРЕДСТВА | | ✓ | ✓ | | |
| УХОД СТРОГО ПО УКАЗАНИЯМ ПРОИЗВОДИТЕЛЯ | | | | | ✓ |
| • НИ В КОЕМ СЛУЧАЕ НЕ ИСПОЛЬЗОВАТЬ АБРАЗИВНЫХ ИЗДЕЛИЙ: ПОРОШКОВ, ЦАРАПОК, РАСТВОРИТЕЛЕЙ • НЕ СМАЧИВАТЬ БОЛЬШИМ КОЛИЧЕСТВОМ ВОДЫ | | | | | |

(TU) BAKIM TALÍMATLARI:

1. TOZUNU DIKKATLICE ALINIZ
2. YUMUŞAK VE TEMİZ BİR BEZİ SABUNLU SU İLE ISLATINIZ

| | KAPLAMA | LAMİNAT YÜZEY | LAKE AHŞAP YÜZEY | LAKE YÜZEY | DÖŞEMELİK KUMAŞ, DERİ |
|--|---------|---------------|---------------------|------------|--------------------------|
| SABUNLU SU (NORMAL SABUN) | ✓ | ✓ | ✓ | ✓ | ✓ |
| DETERJANLI SU | | ✓ | ✓ | | |
| ÜRETİCİNİN BAKIM VE YIKAMA TALÍMATLARI | | | | | ✓ |
| • TOZ, TEL, SOLVENT GIBI AŞINDIRICI URUNLERİ KULLANMAYINIZ • BOL SU İLE ISLATMAYINIZ | | | | | |

(SI) NASVETI ZA VZDRŽEVANJE:

1. SKRBNO OBRISITE PRAH
2. ČISTO IN MEHKO KRPO RAHLO NAVLAŽITE V VODI Z MAJHNO KOLIČINO MILA

| | FURNIR | POVRŠINA LAMINATA | POVRŠINA LES LAK | LAKIRANA POVRŠINA | OBLAZINJENJE USNJE |
|--|--------|----------------------|---------------------|----------------------|-----------------------|
| VODA IN MILO (MEHKO MILO) | ✓ | ✓ | ✓ | ✓ | ✓ |
| VODA Z DODATKOM DETERGENTA | | ✓ | ✓ | | |
| VZDRŽEVATI DOSLEDNO V SKLADU Z NAVODILI PROIZVAJALCA | | | | | ✓ |
| • NIKOLI NE UPORABUJATE ABRÁZIVNIH SREDSTEV: PRAŠKOV, GOBIC IZ ŽICE, TOPIL • NE NAMAKAJTE Z VELIKO KOLIČINO VODE | | | | | |

(HR) UPUTE ZA ODRŽAVANJE:

1. PAŽLJIVO OBRISATI PRAŠINU
2. PREBRISATI ČISTOM, MEKOM TKANINOM NAVLAŽENOJ U BLAGOJ OTOPINI SAPUNA ILI DETERDŽENTA

| | PAPIR | LAMINAT | LAK | DRVO | TEKSTIL KOŽA |
|---|-------|---------|-----|------|--------------|
| OTPINA SAPUNA | ✓ | ✓ | ✓ | ✓ | ✓ |
| OTPINA DETERDŽENTA | | ✓ | ✓ | | |
| NAMIJENSKA SREDSTVA | | | | | ✓ |
| • ZABRANJENA JE UPOTREBA KEMIKALIJA ILI BILO KAKVIH POMOĆNIH SREDSTAVA ZA RIBANJE JAKIH DSREDSTAVA ZA ČIŠĆENJE ILI ČELIČNE VUNE • ZABRANJENO JE ČIŠĆENJE SA PREVIŠE VODE/VLAGE | | | | | |

SCS Sp. z o.o.

Ul. Fabryczna 13

69-110 Rzepin

Polen

polsteria@steinpol.com.pl